



GAMCO

Quality Fenestration Systems & Architectural Metals Since 1986

CONTACT

GAMCO Corporation

www.gamcocorp.com
(718) 359-8833
sales@gamcocorp.com

131-10 Maple Avenue, Flushing, NY 11355

PRODUCTS

D-SERIES COMMERCIAL DOORS
FG-SERIES STOREFRONT SYSTEM
CW250-SERIES CURTAIN WALL SYSTEM
W250-SERIES COMMERCIAL WINDOWS
BD-SERIES BALCONY DOORS
DG400 DRY-GLAZED DOORS
BF-SERIES BIFOLD DOOR SYSTEM
SK2000-SERIES ARCHITECTURAL SKYLIGHTS
ARCHITECTURAL CANOPIES
ARCHITECTURAL COLUMN COVERS
ARCHITECTURAL METAL CLADDING
AND MORE





ABOUT GAMCO

GAMCO Corporation manufactures a wide variety of custom quality fenestration systems and architectural metal components for commercial, institutional and residential properties. Founded in 1986, GAMCO has established a reputation for excellence in quality, customer service, design, and manufacturing. GAMCO products are distributed through its vast network of dealers, glaziers, and fenestration installers throughout the New York metropolitan area and along the East Coast. The company is a New York State-certified Minority and Women-Owned Business Enterprise (MWBE). Located in Flushing, Queens in New York City, GAMCO manufactures curtain wall, storefront, entrance systems, structural skylights, shower enclosures, folding door/wall systems, architectural sunshades, canopies, and a wide assortment of custom metal covers, claddings, and railings. Its experienced engineers and skilled craftsmen work with architects, construction professionals, and property owners to bring their design visions to reality. Since opening in 1986, GAMCO has expanded its physical plant twice. The company currently operates an 80,000 sq. ft. facility with over 60 employees in the heart of New York City and the region's extensive construction market.

QUALITY

GAMCO products are consistently the highest in quality, made with old-world custom craftsmanship that only expert fabricators can render. These fenestration systems are designed to completely integrate with other architectural elements, with exactly matching finishes and style on every component.

EXPERIENCE

GAMCO's experience and dedication is apparent in all aspects of a project – from concept, through engineering and production to delivery. The firm's highly trained and longtime staff has developed and honed the company's technical expertise. Because GAMCO began as an installation firm, its knowledge of building construction ensures flawless product customization every time.

CUSTOM DESIGN

GAMCO's custom manufacturing utilizes industry-leading equipment and machinery with a wide array of capabilities to create any design. Automated CNC hydraulic shear and punch presses, brake metal bending equipment and fine finishing and polishing machinery allow GAMCO technicians to produce beautiful architectural and fenestration components.

OUR STORY

The GAMCO story is one of vision, hard work, and commitment to excellence. The company was co-founded by John Chang and Bee Chew in 1986 as a full-service storefront glazing and installation company for builders and property owners in New York City. Despite their diligence and attention to detail, they were not satisfied with the quality and service GAMCO's fenestration suppliers offered. Chang and Chew then made the bold move away from installation services to manufacturing products themselves. This change of focus enabled GAMCO to deliver the quality, customization and design distinction its customers demanded.

TABLE OF CONTENTS

ABOUT GAMCO	1
GAMCO PRODUCTS	
CW250-SERIES CURTAIN WALL SYSTEM	4
FG-SERIES STOREFRONT SYSTEM	6
D-SERIES COMMERCIAL DOORS	8
W250-SERIES COMMERCIAL WINDOWS	10
BD-SERIES BALCONY DOORS	12
BF-SERIES BIFOLD DOOR SYSTEM	14
SK2000-SERIES ARCHITECTURAL SKYLIGHTS	16
DG400 DRY-GLAZED DOORS	18
ARCHITECTURAL ELEMENTS	20
OTHER METAL PRODUCTS	25
MAJOR PROJECTS	26

CUSTOMER TESTIMONIALS



We love featuring our customers' projects in our catalogs, online content, and social media pages! **Leave your review today**, and you may be featured in our next catalog, proudly showcasing customers whom we have worked with.

We have been a customer of Gamco for 25 years. [T]hey have always been amazing to deal with. Their short leads that are always reliable are very important to me as an owner in order to make our dead lines with our clients. Carlos is always on the ball with his pricing, write ups, and is always a pleasure to deal with.

— AAA Metal & Glass



Great company to work with! Always professional, responsive, and reliable. Their team provides excellent service and makes the process smooth from start to finish. Highly recommend!

— Orders Opulux Glass



o company for aluminum consistently great product, with excellent customer service making our work easier. o do business with.

—WindowFix Inc.



Gamco is always a pleasure to work with! Quick response time and amazing customer service!

— Pexic Windows



Excellent products, superior customer service, always on time and looking to accommodate. Hands down the best to work with!

—Act II Glass



Gamco is our go-to company for storefronts. Consistent service delivered on time, with excellent customer service. Thanks for making our work easier.

A pleasure to do business with!



What a pleasure working with Gamco. [S]o much knowledge and experience. Carlos, you the man! Making everything work out to perfection!

— EZ Glass & Mirrors



Pleasure working with Kasumi at Gamco[.] Easy communication and extremely knowledgeable Rep. Great lead time, reasonable pricing & Outstanding Service!

— Pro Classic



Knowledgeable staff and excellent products, [d]oors are strong and nice, pleasure doing business with them!

— Affordable Doors + Windows







CW250-SERIES CURTAIN WALL SYSTEM

The CW250-Series Curtain Wall System combines high-quality construction with optimum performance, tailored to meet the requirements of demanding architectural wall systems. Our CW250P has a polyamide cap in place of aluminum that helps increase our energy efficiency. Besides enhancing the energy efficiency, architectural design and aesthetic appeal, GAMCO also provides structural design and analysis along with a full line of drafting production services. Our systems allow for factory assembly, unitizing and outside glazing without compromising integrity.

STOCK FINISHES

CW250 & CW250P

-  Clear Anodized
-  Dark Bronze Anodized

Some custom finishes may be possible upon request.

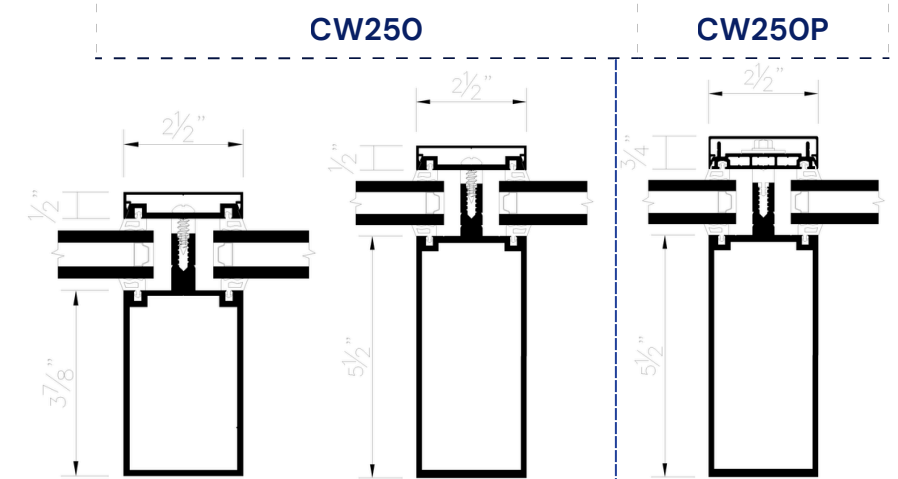

	CW250	CW250P
Member	3-7/8"	5-1/2"
U-factor	0.42	0.34

Based on COG U-factor 0.24.

PERFORMANCE

	TYPE	CW250	CW250P
	SIZE (WIDTH X HEIGHT)	15'-0" X 30'-0"	15'-0" X 30'-0"
ASTM E 283-04	Static Pressure Air Infiltration @ 6.24 psf	<0.01 cfm/ft ²	<0.01 cfm/ft ²
ASTM E 331-00	Static Pressure Water Resistance	15 psf	15 psf
ASTM E 330-02	Uniform Structural Design Load ± Pressure	60 psf	50 psf
	Uniform Structural Over Load ± Pressure	90 psf	75 psf
AAMA 501-1-05	Dynamic Pressure Water Resistance	15 psf	15 psf
AAMA 507-15	Thermal Simulation (Glass U-Factor 0.24)	0.41 - 0.42	0.34
ASM E90	Acoustical Performance	STC: N/A OITC: N/A	STC: 37 OITC: 30

FG-SERIES STOREFRONT SYSTEM

F G450 and FG451 storefront systems are available in shear block and screw spline fabrication. FG450 utilizes 1/4" and up to 1/2" glass, while FG451 utilizes 1" insulated glass.

FG451T features thermal-break designs to reduce heat transfer and keep internal surfaces warmer. FG451T accepts 1" insulated glass.

Utilizing Ensinger Insul-Bar thermal capabilities, our newest **FG451IS Isothermal Frame** enhances your storefront's performance while keeping the sleek GAMCO look you know and love. This option accepts 1" to 1-3/8" glass.

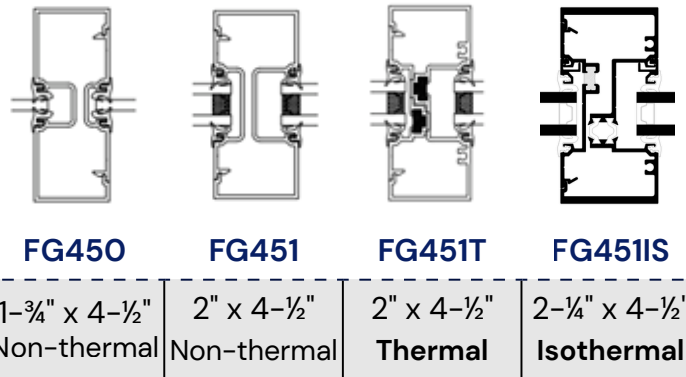

STOCK FINISHES

FG450	FG451	FG451T	FG451IS
Clear Anodized	Clear Anodized	Clear Anodized	Clear Anodized
Dark Bronze Anodized	Dark Bronze Anodized	Dark Bronze Anodized	Black-Painted
White-Painted	White-Painted	White-Painted	
Black-Painted	Black-Painted	Black-Painted	

Cladding or custom finish may be possible upon request. Ask a sales representative for more information.



PERFORMANCE

TYPE		FG450	FG451	FG451T	FG451IS
SIZE (WIDTH X HEIGHT)		10'-6" X 8'-0"	10'-6" X 8'-0"	10'-6" X 8'-0"	117" x 108-1/8"
ASTM E 283-91	Air Infiltration @ 6.24	<0.19 cfm/ft ²	<0.11 cfm/ft ²	<0.17 cfm/ft ²	<0.01 cfm/ft ²
ASTM E 331-93	Water Test Pressure	8.36 psf	12.11 psf	6.06 psf	ASTM E547 12.00 psf
ASTM E 330-96	Uniform Structural Design Pressure (Overload Value)	+30.08 psf -30.08 psf	+45.11 psf -45.11 psf	+37.59 psf -37.59 psf	+45 psf -45 psf
AAMA 507-15	Thermal Simulation (Glass U-Factor 0.24)	N/A	N/A	0.38	0.40
ASTM E90	Acoustical Performance	N/A	STC: 35 OITC: 28	STC: 35 OITC: 28	STC: 38 OITC: 31



PERFORMANCE

TYPE		D200 (NARROW)	D350 (MEDIUM)	D500 (WIDE)	TD350 (THERMAL)
SIZE (WIDTH X HEIGHT)		3'-0" X 7'-0"	3'-0" X 7'-0"	4'-0" X 8'-0"	3'-0" X 7'-0"
ASTM 283-91	Air Infiltration @ 1.57 psf	0.08 cfm/ft ²	0.29 cfm/ft ²	N/A	0.18 cfm/ft ²
ASTM E 331-96	Water Test Pressure	0	0	0	0
ASTM E 330-97	Uniform Structural Test ± Pressure	30 psf	45 psf	80 psf	75 psf
AAMA 507	Thermal Simulation (Glass U-Factor 0.24)	N/A	0.70	N/A	0.41
ASM E90	Acoustical Performance	STC: N/A OITC: N/A	STC: 31 (pair), 30 (single) OITC: 28 (pair), 27 (single)	STC: N/A OITC: N/A	OITC: 34





D-SERIES COMMERCIAL DOORS

FEATURES & OPTIONS

Butt Hinge / Offset Pivot
 Center Hung / Offset Hung with C.O.C / Floor Closer
 Standard / C-Pull and Push Handles
 Long / Short Lever Handle
 Paddle Release / Panic Device
 Standard MS Lock / Latch Lock
 Electric Strike / Magnetic Lock

Specific hardware may be available upon request.

STOCK FINISHES

-  Clear Anodized
-  Dark Bronze Anodized
-  White-Painted
-  Black-Painted (D350/TD350 only)

Cladding or custom finishes may be available upon request.

D-SERIES DOORS WITH FG-SERIES STOREFRONT SYSTEM

FG450	1¾" x 4½"	D200 (narrow), D350 (medium), D500 (wide)
FG451	2" x 4½"	D200 (narrow), D350 (medium), D500 (wide)
FG451T	2" x 4½"	D200 (narrow), D350 (medium), D500 (wide)
FG451IS	2¼" x 4½"	TD350 (medium) ONLY



Door and storefront entrance systems. Custom arching, finishing, mid-rails, and more available upon request.

W250-SERIES COMMERCIAL WINDOWS

We offer various options for our CW- and AW-Rated commercial and heavy-commercial windows.

FEATURES & OPTIONS

2-1/2" Profile / Thermal Break

W250C/Commercial-Grade: 1/16" Wall Thickness.

W250HC/Heavy-Duty: 1/8" Wall Thickness.

1" Glass Prep.

4-Bar Hinges / Cam Handles

Casement Hinges / Rotary Handles



Multi-Point Lock (for casement)

4" Limiting Device

Optional screens

Custom hardware options may be possible.

STOCK FINISHES

-  Clear Anodized
-  Dark Bronze Anodized
-  White-Painted

Custom finishes may be available upon request.

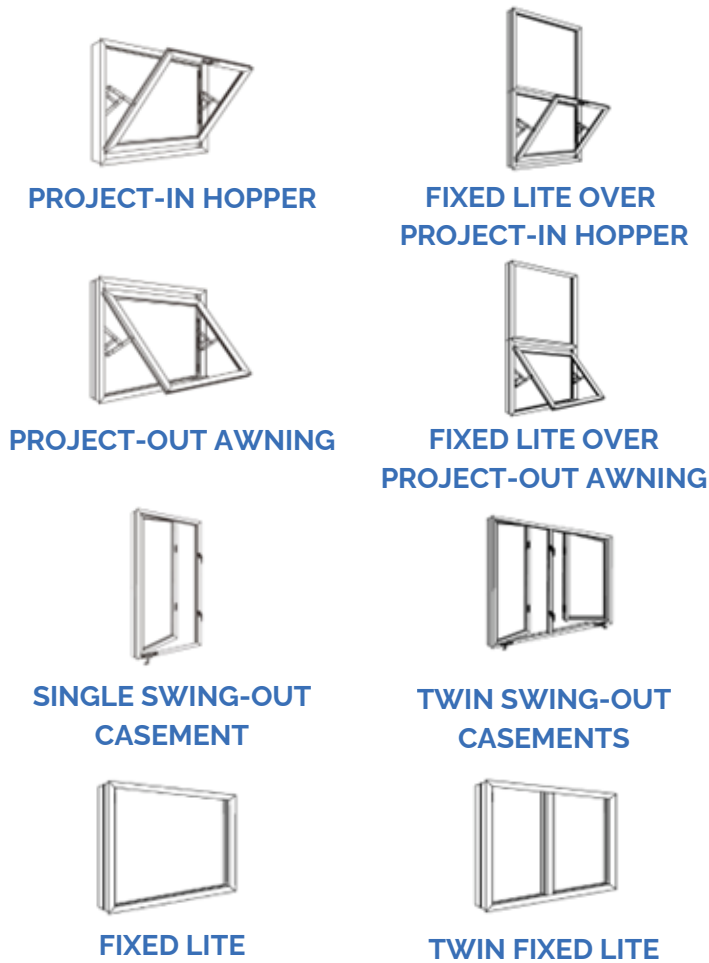

PERFORMANCE & SIZING

	TYPE	AAMA RATING	MINIMUM SIZE	MAXIMUM SIZE
W250C	CASEMENT	CW30	18" x 24"	30" x 50"
	TWIN CASEMENT	CW30	36" x 24"	60" x 50"
	FIXED	CW30	24" x 24"	84" x 84"
	AWNING	CW30	18" x 18"	60" x 48"
	HOPPER	CW50	18" x 18"	60" x 48"
W250HC	CASEMENT	AW40	18" x 24"	30" x 50"
	TWIN CASEMENT	AW40	36" x 24"	60" x 50"
	FIXED	AW40	24" x 24"	84" x 84"
	AWNING	CW30	18" x 18"	60" x 48"
	HOPPER	CW40	18" x 18"	60" x 48"



BD-SERIES BALCONY DOORS





GAMCO proudly offers two options for our balcony doors — our classic out-swing doors, and our **new thermal balcony doors**, available in out-swing or in-swing configurations.

STOCK FINISHES

BD3000/BD3001 (NEW)

 Black-Painted

BD325 (CLASSIC)

-  Clear Anodized
-  Dark Bronze Anodized
-  White-Painted

Some custom finishes may be possible upon request.

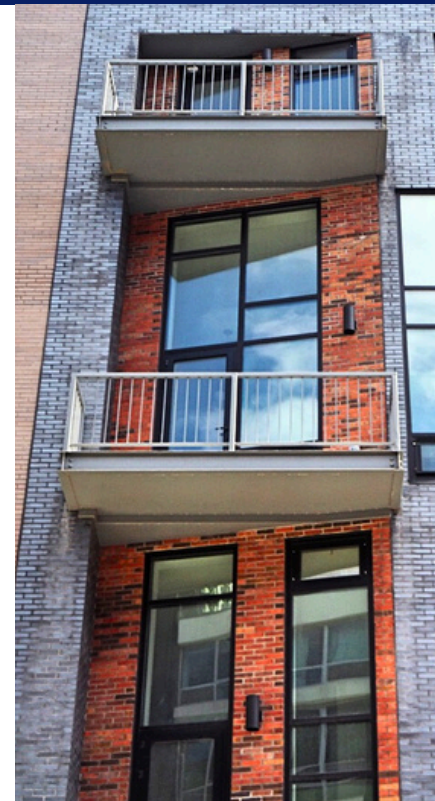
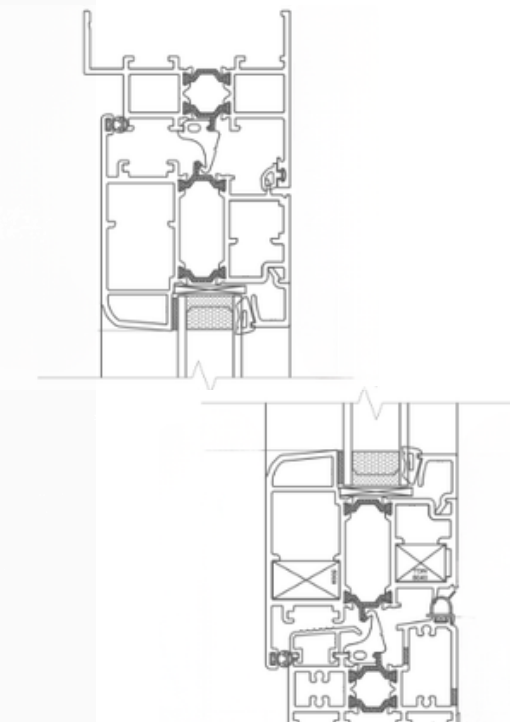

FEATURES AND OPTIONS

BD325 (CLASSIC)

AW50 Rating

- 3-1/4" frame profile
- 1/8" wall thickness
- Insul-bar thermal break
- 1" Insulated tempered glass
- Multi-point European lockset
- No key cylinder

- Transom and sidelite
- Out-swing only

BD3000 (NEW)

AW75 (BD3000/out-swing) Rating AW60 (BD3001/in-swing) Rating

- 3-1/4" frame profile
- Insul-bar ThermoBlock™ thermal break
- 1" insulated tempered glass
- Multi-point European lockset
- Cylinder key lock
- Minimalist handle design

- Transom and sidelite
- Out-swing and in-swing



SINGLE DOOR



SINGLE DOOR
W/ TRANSOM



PAIR DOOR

PERFORMANCE

TYPE		BD325	BD3000	BD3001
WIDTH X HEIGHT		48" X 96"	OUT-SWING	IN-SWING
AAMA 920	Operating/Cycling Performance	30 lbf		
AAMA 1304	Forced Entry Resistance	300 lbf		
ASTM E 283	Static Pressure Air Infiltration @ 6.20 psf	<0.10 cfm/ft ²	0.10 cfm/ft ²	0.10 cfm/ft ²
ASTM E 547	Cyclic Pressure Water Resistance	10 psf	12 psf	12 psf
ASTM E 330	Static Pressure Water Resistance	10 psf		
ASTM E 330	Uniform Structural Design Load ± Pressure	50 psf	112.5 psf	90 psf
	Uniform Structural Over Load ± Pressure	75 psf		
AAMA 507-15	Thermal Simulation (Glass U-Factor 0.24)	0.42	0.32 - 0.54	0.32 - 0.54
AAMA 1503-09	Physical Thermal Performance	0.43		
ASTM E90	Acoustical Performance	STC: 38 OITC: 33	OITC: 34	OITC: 34

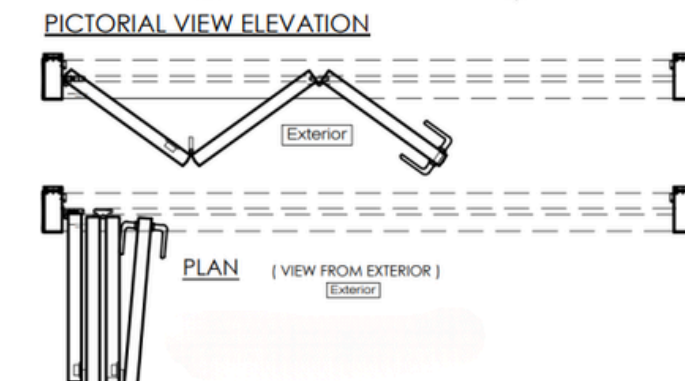
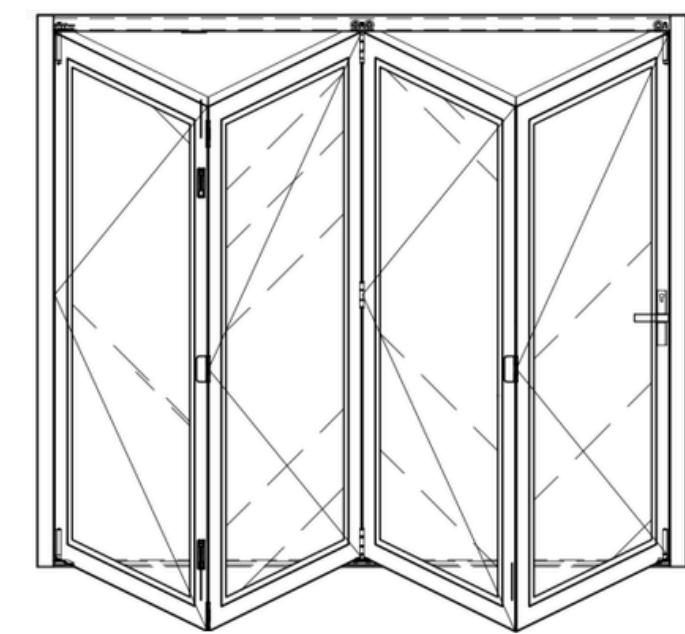
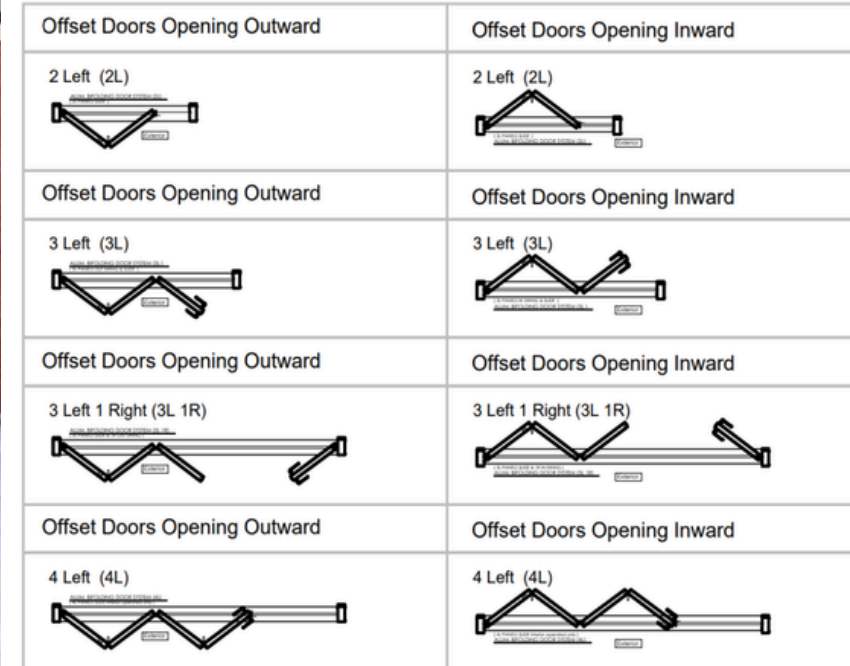

BF-SERIES BIFOLD DOOR SYSTEM

CONFIGURATIONS

BF200 (NARROW-STILE)	BF350 (MEDIUM-STILE)	BF500 (WIDE-STILE)
2-1/8" stile and top rail	3-1/2" stile and top rail	5" stile and top rail
3-1/8" bottom rail	5" bottom rail	10" bottom rail

STOCK FINISHES

BF-SERIES DOORS

- Clear Anodized
- Dark Bronze Anodized

Custom finish may be possible upon request. Ask a sales representative for more information.



FEATURES & OPTIONS

- Standard hardware* (stainless steel finish):
- Pivot
 - Hanger
 - Hinge set
 - Standard latch lockset with lever handle
 - Flushbolt control on interior
 - Concealed overhead track and bottom saddle

1/4" or 1" glazing options
5/8" muntin
1-1/2" mid- & 10" bottom rails.

Load Capacity: 330 lbs per 3'x7' door leaf.

*Special hardware available upon request. Please consult with sales rep.



SK2000-SERIES ARCHITECTURAL SKYLIGHTS

GAMCO custom-manufactures structural glass skylights and solariums for various commercial applications.

The SK2000-Series Skylight System utilizes extruded aluminum members with integral condensate gutter gasket pockets to channel any moisture to the exterior of the structures, thus preventing air and moisture infiltration. This offers a clean appearance, while structurally meeting the required design loads and deflection criteria.

Units include pressure bars and beauty caps for easy glazing, and are available in curb mount self-flashing styles to the exact designs needed for your projects.

STOCK FINISHES

-  Clear Anodized
-  Dark Bronze Anodized
-  White-Painted

Custom finishes may be available upon request.

CONFIGURATIONS

- Single pitch/lean-to
- Single pitch w/ gable ends
- Double pitch
- Double pitch w/ gable ends
- Double pitch w/ hip ends
- Pyramid
- Octagonal
- Sunrooms/Solariums**

Custom configurations and dimensions may be possible. Ask a sales representative for more information.

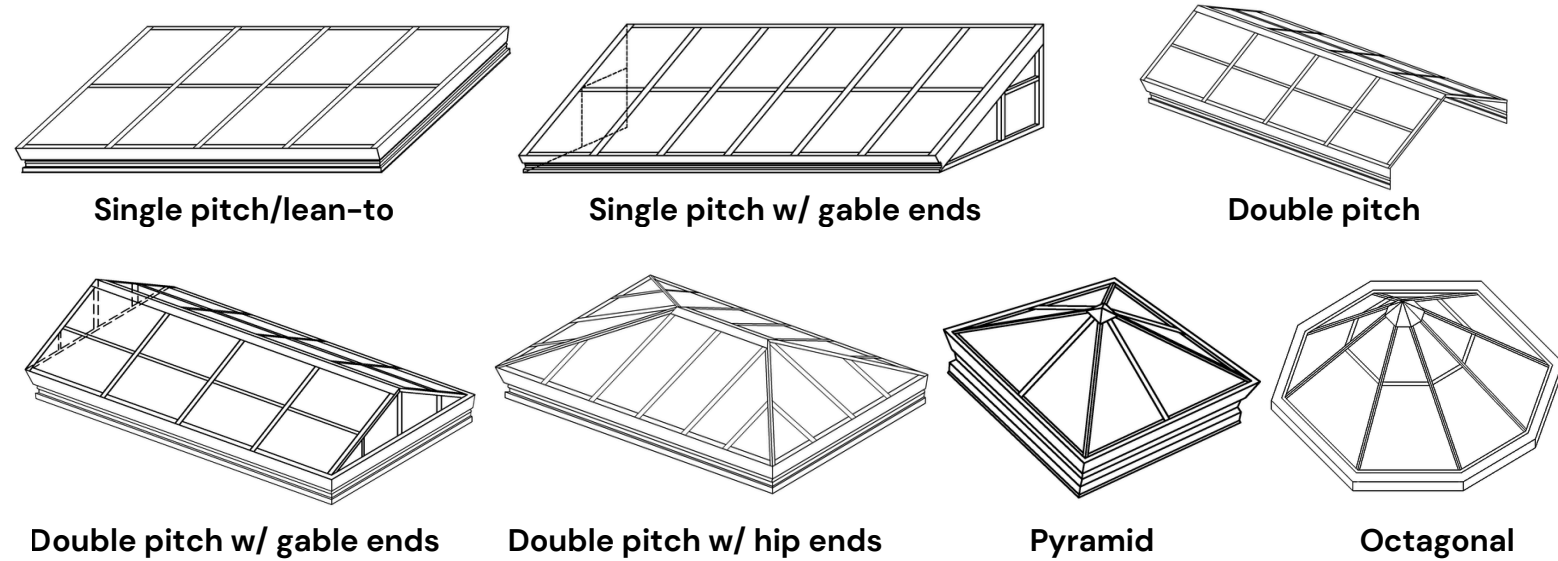

PERFORMANCE

TYPE		Single Pitch	Pyramid	Double Pitch Gable End
SIZE (WIDTH X LENGTH X HEIGHT)		10'-0" (W) X 10'-0" (L)	10'-0" (W) X 10'-0" (L) X 3'-7" (H)	5'-0" (W) X 10'-0" (L) X 2'-2" (H)
ASTM E 283-99	Static Pressure Air Infiltration @ 6.24 psf	<0.01 cfm/ft ²	<0.01 cfm/ft ²	<0.03 cfm/ft ²
ASTM E 331-00	Static Pressure Water Resistance	15 psf	15 psf	18 psf
ASTM E 330-96	Uniform Structural Design Load ± Pressure	90 psf	90 psf	120 psf
	Uniform Structural Over Load ± Pressure	120 psf	120 psf	180 psf

DG400 DRY-GLAZED DOORS

Installing our DG400 Dry-Glazed Door is quick, easy, and painless. Door replacement can be finished in as little as an hour! We also offer a quick lead time, as quickly as 3 business days for standard configurations, making our DG400 a quality, budget-friendly product for a sleek finish.



STOCK FINISHES

DG400

- Clear Anodized
- Dark Bronze Anodized

Some custom finishes may be possible upon request.



CONFIGURATIONS

TYPE A

1-3/4" x 4" header
1-3/4" x 4-1/2" header
2" x 4-1/2" header

- 1/2" monolithic tempered glass
- Top patch fitting
- Bottom patch fitting
- Center-hung, single / double-acting
- 12" / 12" straight c-pull B.T.B.
- International 200-Series C.O.C.

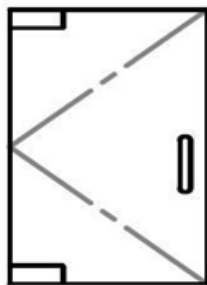

(A)

TYPE B

1-3/4" x 4" header
1-3/4" x 4-1/2" header
2" x 4-1/2" header

- 1/2" monolithic tempered glass
- Top patch fitting
- Bottom patch fitting
- Patch lock
- Center-hung, single / double-acting
- 12" / 12" straight c-pull B.T.B.
- International 200-Series C.O.C.

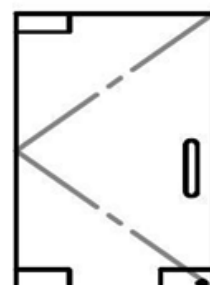

(B)

TYPE C

1-3/4" x 4" header
1-3/4" x 4-1/2" header
2" x 4-1/2" header

- 1/2" monolithic tempered glass
- Top patch fitting
- 4-3/8" bottom shoes with locks
- Center-hung, single / double-acting
- Cylinder / thumbturn / dummy
- 12" / 12" straight c-pull B.T.B.
- International 200-Series C.O.C.



(C)

TYPE D

1-3/4" x 4" header
1-3/4" x 4-1/2" header
2" x 4-1/2" header

- 1/2" monolithic tempered glass
- 4-3/8" top and bottom shoes w/ locks
- Center-hung, single / double-acting
- Cylinder / thumbturn / dummy
- 12" / 12" straight c-pull B.T.B.
- International 200-Series C.O.C.







(D)



ARCHITECTURAL COLUMN COVERS ARCHITECTURAL ELEMENTS

GAMCO architectural column covers are available for interior or exterior applications. Column covers and beam wraps can be round, square, or oval in shape with reveals or butt joints depending upon the custom design requirements of your project.

MATERIAL/FINISH OPTIONS





-  Aluminum
-  Stainless Steel
-  Brass
-  Black or White-Painted

Some custom finishes may be possible upon request. Ask a sales representative for more information.

ARCHITECTURAL CANOPY ARCHITECTURAL ELEMENTS

GAMCO's custom canopies can be manufactured to your designs and specifications, for a wide variety of commercial and residential uses.

MATERIAL/FINISH OPTIONS

-  Aluminum
-  Stainless Steel
-  Brass
-  Black or White-Painted

Some custom finishes may be possible upon request. Ask a sales representative for more information.

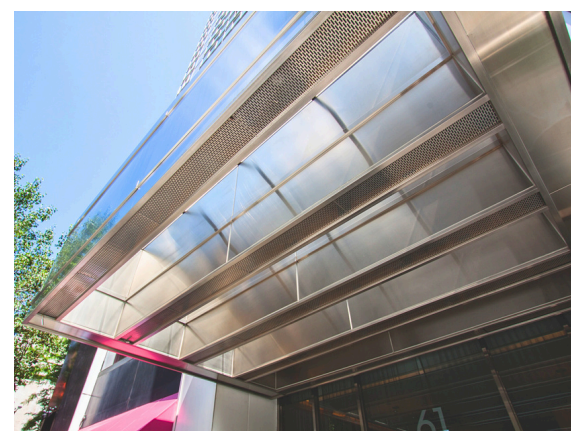





ARCHITECTURAL METAL CLADDING

ARCHITECTURAL ELEMENTS

Our architectural metal cladded products, including doors and storefronts, provide architects, engineers, contractors, and façade installers with innovative and high-performance cladding solutions where aesthetics and performance are important.

MATERIAL/FINISH OPTIONS

-  Aluminum
-  Stainless Steel
-  Brass
-  Black or White-Painted

Some custom finishes may be possible upon request. Ask a sales representative for more information.





RAILINGS

ARCHITECTURAL ELEMENTS

GAMCO's custom-designed railings can meet any model conceptualized by the project's architects or designers. We offer dimensional accuracy in small bends and in large radius bending railing configurations alike.



MATERIAL/FINISH OPTIONS

-  Stainless Steel
-  Brass







L-SERIES ALUMINUM LOUVERS

ARCHITECTURAL ELEMENTS

Our L-Series Louvers are fabricated in-house to order and designed to seamlessly integrate with various products, such as curtain wall, windows, sunshades, and more. Available in 45-degree angle blades, with a frame depth of 2-1/2". May request optional screens.

FINISH OPTIONS

-  Clear Anodized
-  Dark Bronze Anodized
-  White-Painted

Some custom finishes may be possible upon request.

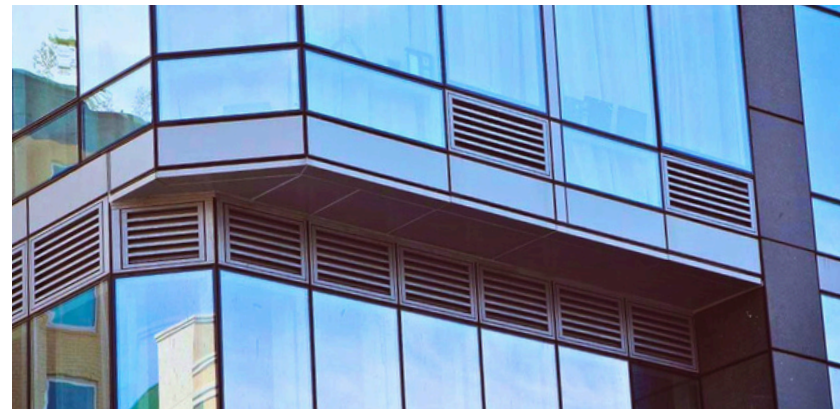

OTHER METAL PRODUCTS

GAMCO fabricates a variety of custom framing structures for decorative, advertising, and informational light boxes, both indoor and outdoor in many shapes and sizes. Architectural perforated metals are available in a wide assortment of materials and patterns. GAMCO also offers the highest quality bar grilles for use in floor wall, sill or ceiling applications with several core and frame styles. Materials include aluminum, brass, bronze and stainless steel, and are available in a number of finishes.

CAPABILITIES AND SELECTIONS

- | | | |
|-------------------|------------------|-------------|
| Counter cladding | Light boxes | Kiosks |
| Railing panels | Pilaster columns | Bar grilles |
| Perforated panels | Clock towers | Screens |

MATERIAL/FINISH OPTIONS

- | | |
|---|--|
|  Aluminum |  Brass |
|  Stainless Steel |  Black or White-Painted |

Some custom finishes may be possible upon request.



MAJOR PROJECTS



CATON FLATS

New-construction 14-story mixed-use development in Brooklyn, intended for residential and commercial use.

Products:

- CW250P curtain wall with polyamide
- L-series louvers
- DG400 dry-glazed doors
- SK2000-series skylights, pyramid

Installer: Lettire Construction



FAR ROCKAWAY VILLAGE

This large-scale project in eastern Queens encompassed a large area of development. GAMCO provided custom-fabricated products for multiple facades across several buildings.

Products:

- Custom-fabricated CW250P curtain wall
- Multi-story storefronts
- Custom-fabricated GAMCO doors

Installer: Lettire Construction

THE ROCKLEIGH

Several custom-fabricated SK2000 Skylights were provided for this wedding reception ballroom, bringing in lots of natural light to the elegant space.

Products:

- SK2000-series skylights, double-pitched with hip ends

Installer: AAA Glass & Metal



136 SUMMIT AVENUE

Located in New Jersey, The Summit is a 9-story tall apartment community with 99 beautifully designed units.

Products:

- FG450 and FG451 storefront
- CW250-series curtain wall
- W250C commercial-grade windows
- D350 medium-stile commercial doors

Installer: Affordable Doors + Windows



RUMC EMERGENCY ROOM

The fenestration products supplied by GAMCO allow lighting and ease of entry to several new trauma bays, urgent care areas, and operating suites.

Products:

- Curtain wall facade system
- Storefront framing system
- Thermally broken, impact-resistant doors

Installer: The Jobin Organization



MONTEBELLO GATEWAY

Multiple curtain walls, windows, and doors were supplied for this new construction mixed-use medical office in Montebello, NY

Products:

- D200 and D350 commercial doors
- FG540 and FG451 storefront
- W250C commercial-grade windows
- CW250-series curtain wall

Installer: EZ Glass & Mirrors

MAJOR PROJECTS



165 DIVISION STREET

Established in 1977, Extra Space Storage has grown to be the largest U.S. operator of self-storage properties, operating over 4,000 properties, serving both residential and business customers.

Products:

- D350 medium-stile doors
- CW250P curtain wall with polyamide
- FG451T storefront

Installer: ABCO Glazing

IRON POINTE APARTMENTS

Located at 39 Madison Street, this property offers various apartment configurations, state-of-the-art gym, lounges, rooftop views of the NYC skyline, and more.

Products:

- D-series commercial doors
- FG-series storefront

Installer: Affordable Doors & Windows

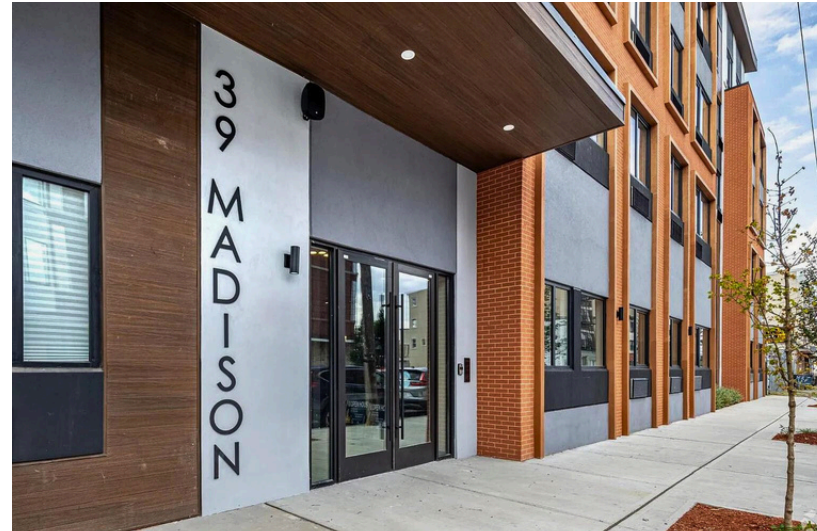

42 BROAD

42 Broad is a luxury apartment that offers a nurturing and inclusive environment, with apartments providing a warm indoor experience, outdoor swimming pool, and indoor gym.

Products:

- Sourced and custom-fabricated a number of curtain walls for the facade

Installer: Ross Window Corporation



GAMCO PRODUCTS AT A GLANCE

As custom-metal fabricators, GAMCO is able to offer a variety of finishes, features, and options for 13+ product lines.



STOREFRONTS

- Non-thermal or thermal-break options
- Various profile options
- Custom arches, sizes, and finishes

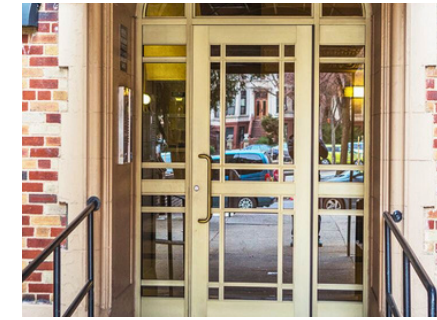

COMMERCIAL DOORS

- Narrow, medium, or wide-stile options
- Single/pair, center or off-set hung
- Various in-stock hardware to suit any project's needs
- Custom hardware, sizes, and finishes

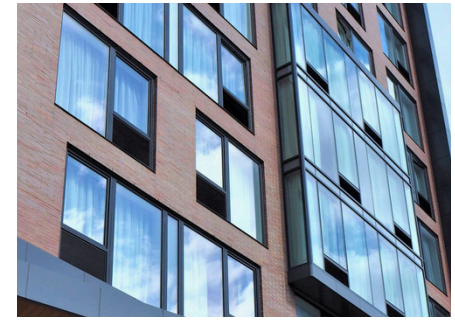

COMMERCIAL WINDOWS

- Casement, awning, hopper, fixed, single/twin, or custom-configurations
- Optional screens
- Custom sizes and finishes



CURTAIN WALLS

- 2-1/2" x 3-7/8" or 2-1/2" x 5-1/2" back member profiles
- Thermal or non-thermal options
- Pre-fabricated stick systems, 1" glass
- Custom arches, sizes, and finishes



BALCONY/DRY-GLAZED

- Specialty doors to fit any space
- Compatible with other GAMCO product lines for seamless integration
- Custom hardware, sizes, and finishes



BI-FOLD DOOR SYSTEMS

- 2-1/2" x 5" profile head track/jamb
- Outswing (standard), inswing (opt.)
- Custom leaf configurations available
- Custom hardware, sizes, and finishes

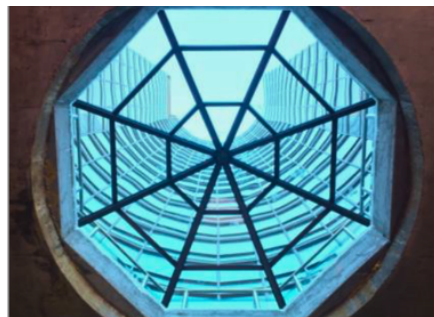

SKYLIGHTS

- Curb-mounted, self-flashing
- Pressure bar and beauty cap
- Single pitch, double pitch, double pitch with hip/gable ends, pyramid, octagon, solarium/sunroom, and more
- Custom pitches, sizes, and finishes



ARCHITECTURAL RAILINGS

- Small and large-radius bending configurations
- Stock finishes in stainless steel, brass, and bronze
- Custom layouts, sizes, and finishes

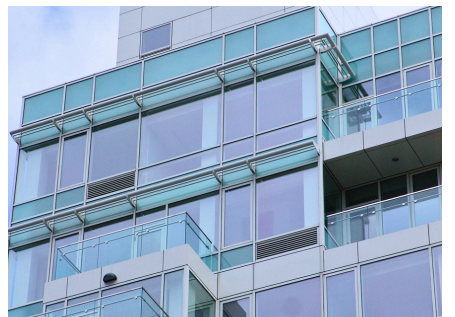

OTHER PRODUCTS

- Steel, aluminum, and bronze cladding
- Canopies
- Column covers
- Louvers and screens
- Other custom metal products