

**L325 SERIES LOUVER  
45° ANGLE DOUBLE BLADE  
SIGHT PROOF**

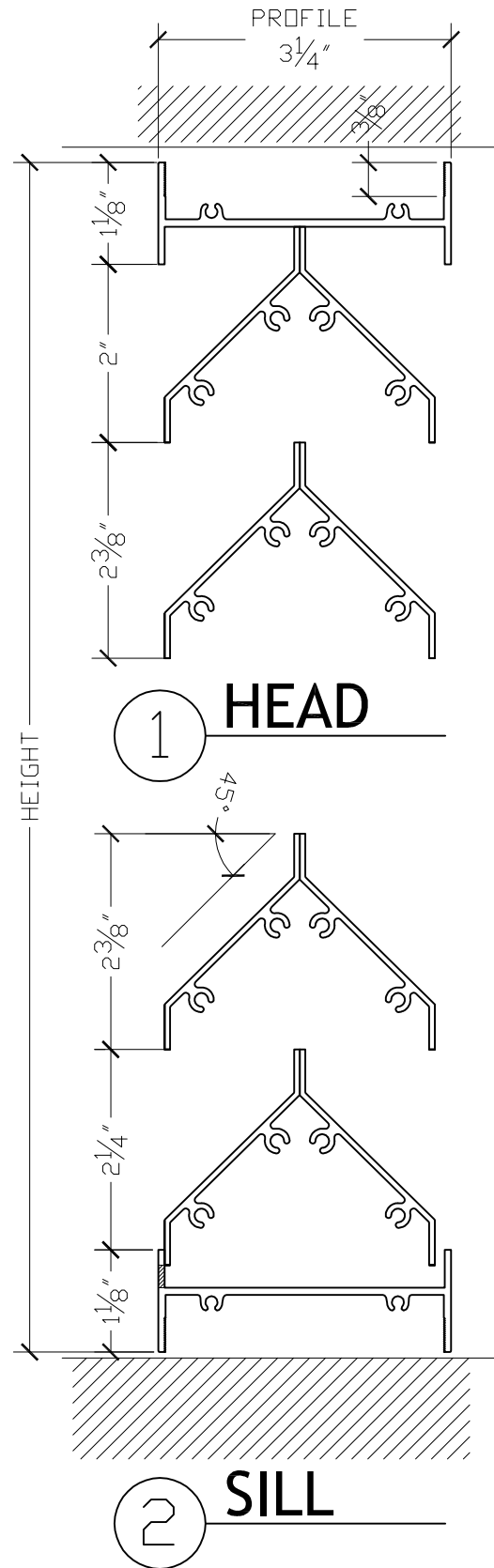
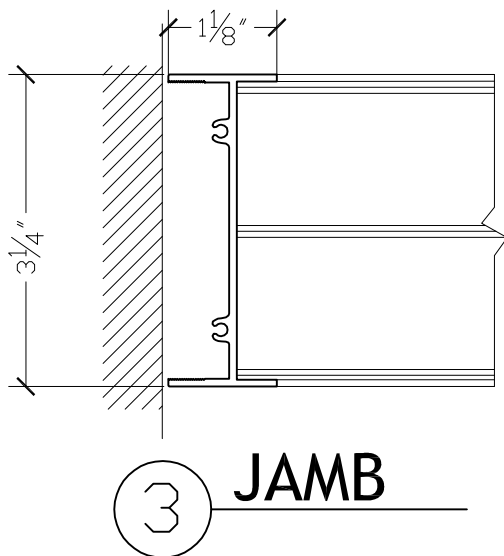

SHEET #	Drawn by: C. CHAN	Customer
	Checked by:	
	Date:	
	Scale: 6" = 1'-0"	

Project Name: 45° ANGLE BLADE SIGHT PROOF LOUVER
---

Revisions		
No.	Date	Description

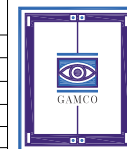

**GAMCO CORP.**  
MANUFACTURER OF QUALITY  
FENESTRATION PRODUCTS  
131-10 Maple Ave. Flushing, N.Y. 11355  
Tel: (718) 359-8833 Fax: (718) 359-8661  
info@gamcocorp.com www.gamcocorp.com