

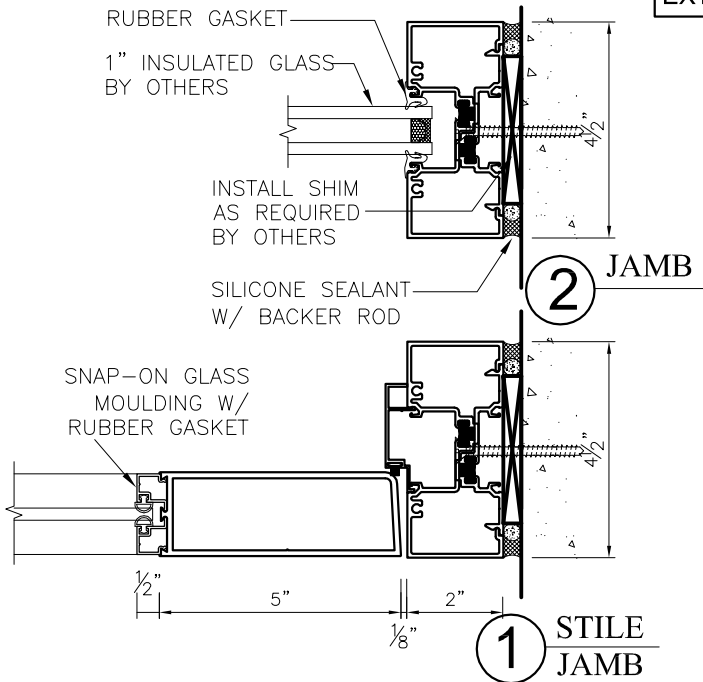

IRISION™ D500 SERIES FLUSH GLAZING SYSTEM

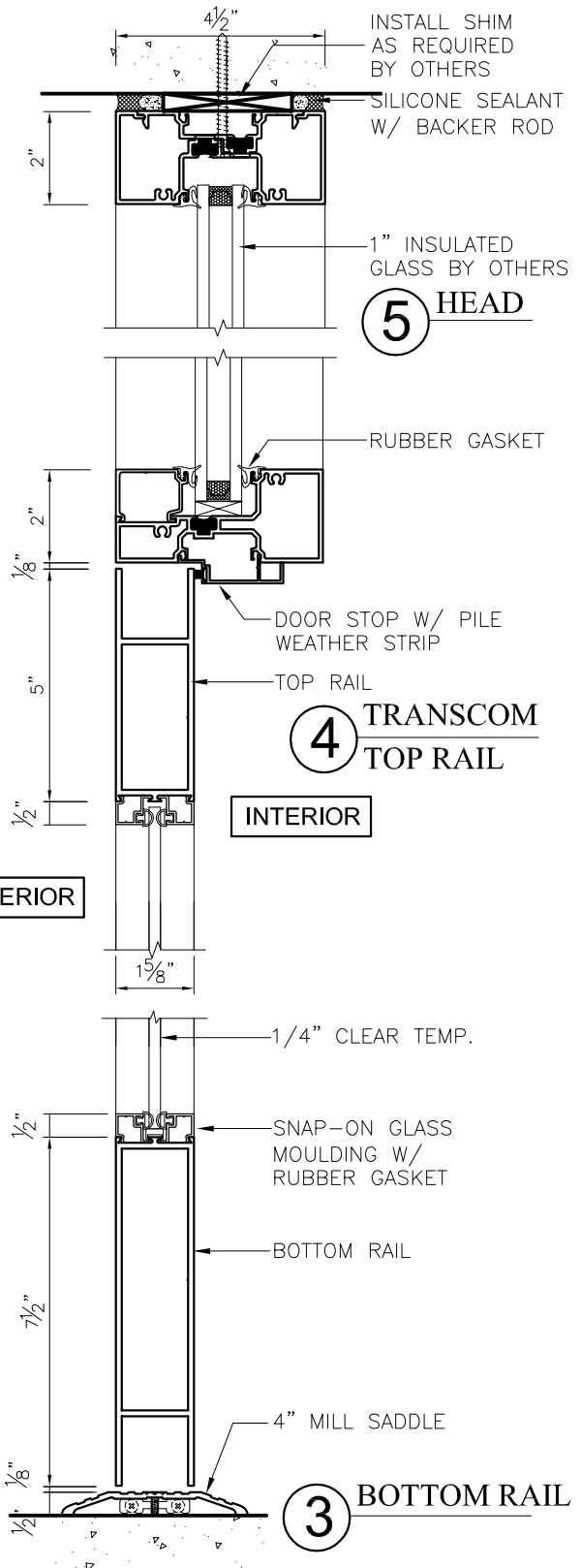

SHEET #	Drawn by: K. S. Lee	Customer	Revisions			 GAMCO CORP. MANUFACTURER OF QUALITY FENESTRATION PRODUCTS 131-10 Maple Ave. Flushing, N.Y. 11355 Tel: (718) 359-8833 Fax: (718) 359-8661 info@gamcocorp.com www.gamcocorp.com
	Checked by: C. Chan		Project Name:	No.	Date	
	Date:					
	Scale: 3" = 1'-0"					